

99473

Dimensions

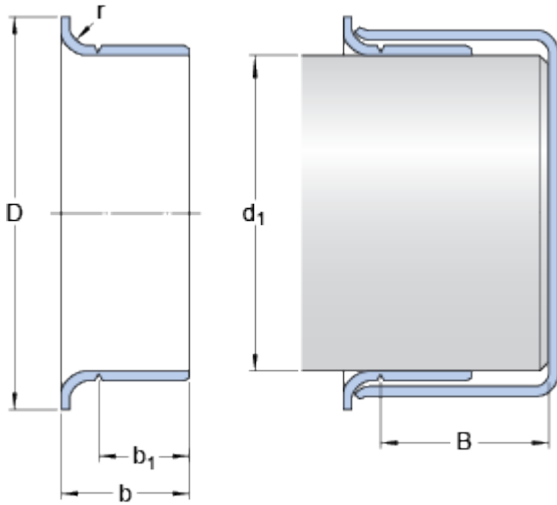

Nominal dimensions

d_1		120	mm
D		129.794	mm
Tolerance outside diameter D	\pm	1.6	mm
b		24.994	mm
Tolerance width b	\pm	0.8	mm
b_1		19.99	mm
Tolerance width b_1	\pm	0.8	mm
B	max.	32.004	mm
r	max.	3.18	mm

Shaft diameter range

d_1	min.	119.888	mm
d_1	max.	120.091	mm